



KAHLES



HELIA RD

ANLEITUNG/INSTRUCTIONS

20018 HELIA RD PICATINNY MOUNT

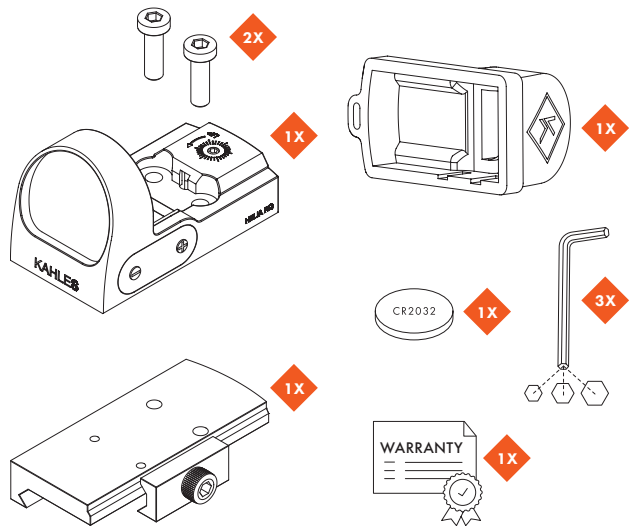

20019 HELIA RD ADAPTER PLATE

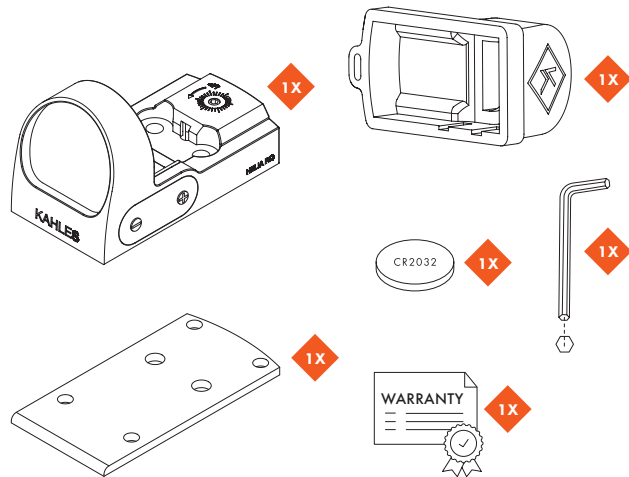

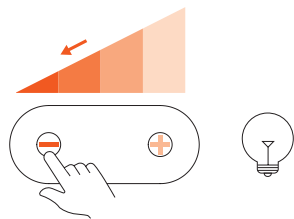
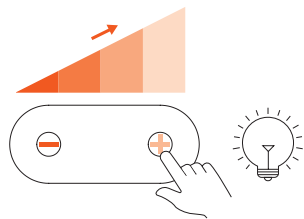
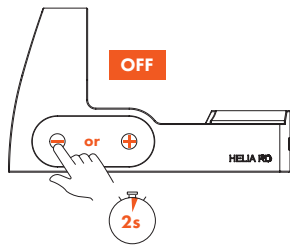
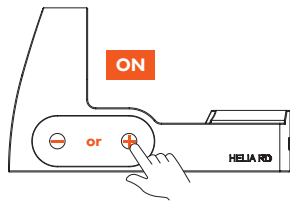

AUTOMATICLIGHT

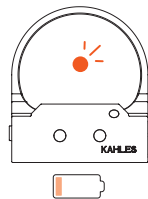
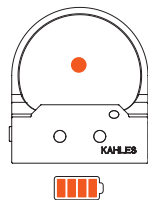
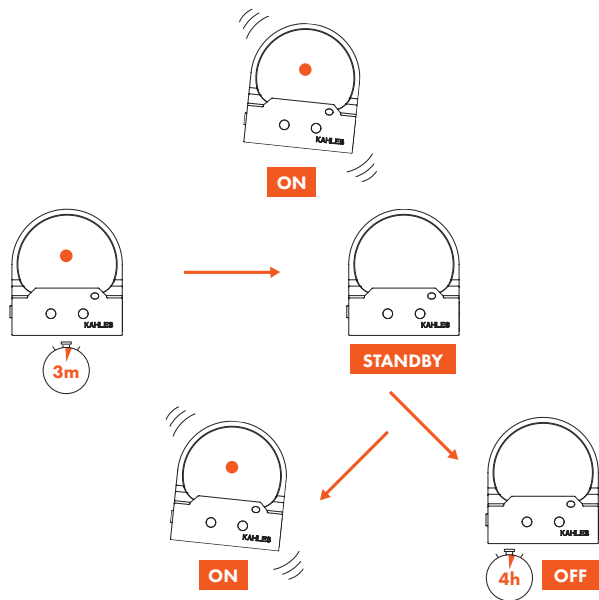

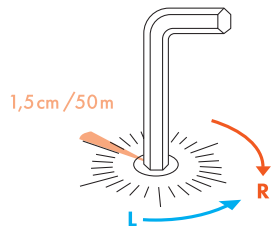
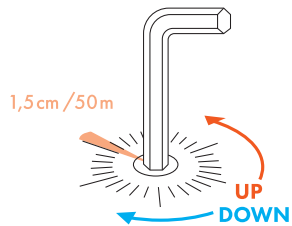
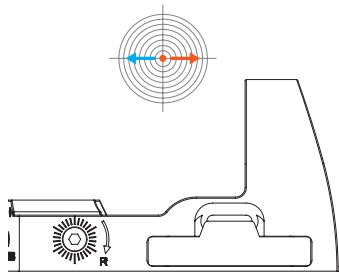
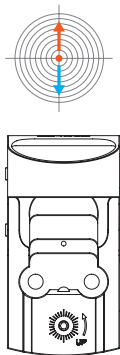

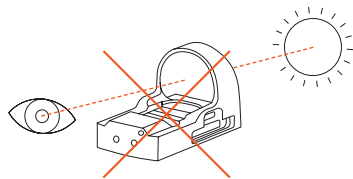
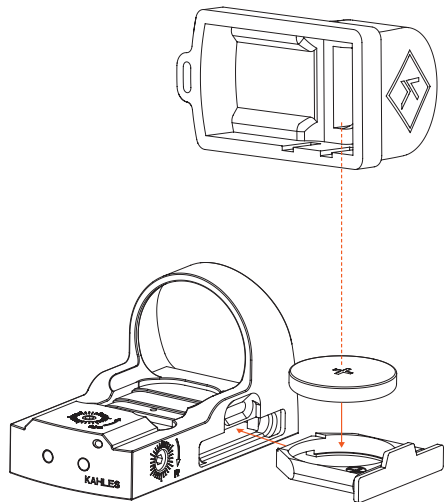

CE

www.kahles.at/service



www.kahles.at

KAHLES Gesellschaft m.b.H. | Danfoss-Straße 5 | 2353 Guntramsdorf | Austria
T: +43/2236/520 20/0 | info@kahles.at